



# TripHopper

( Art : 290 - 000 x x )

## Submitting for:

<input type="checkbox"/> Quote	<input type="checkbox"/> Order

Date	
------	--

## Dealer information

Name	
Street	
Postal code/ City	
Contact person	
E-mail	
Phone	
Fax	

## Shipping information

Name	
Street	
Postal code/ City	
Contact person	
Country	



## User information

Name		<b>Mandatory information to ensure correct configuration</b>
Age		
Weight		
1) Standing height - cm		
2) Hip width sitting - cm		
3) Upper leg length - cm		
4) Lower leg length - cm		
5) Elbow height - cm		

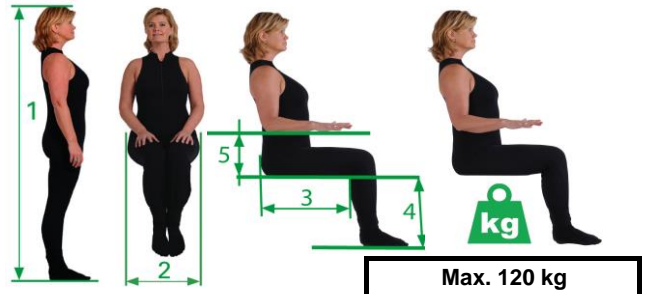

## Required settings

Front seat height (F) - cm		Standaard = 51
Back seat height (G) - cm		Standaard = 49
Wheelbalance (W) - cm		Standaard = 7

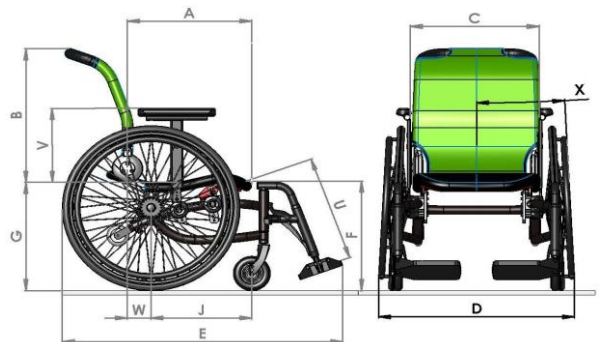

<b>Baseprice</b>	<b>€</b>	<b>2.610</b>
------------------	----------	--------------

## Information of the wheelchair

### Adjustments



Additional cost options	€
Additional cost adjustment	€
<b>Price Exclusive VAT</b>	<b>€</b>
<b>Packaging and transport</b>	

All our deliveries are subject to the General Conditions for the Supply of Mechanical, Electrical and Electronic Products (Orgalime S2000) as published by the Orgalime, The European Engineering Industries Association. Order form January 2014 (Specifications are subject to change without notice)

O<sup>4</sup> Wheelchairs T: +31 (0) 315 396 900 Markenweg 9, 7051 HS Varsseveld, Netherlands F: +31 (0) 315 396 909 E: info@o4.eu I: www.o4.eu

## Seat width (C)

<input type="checkbox"/> 34cm	<input type="checkbox"/> 36,5cm	<input type="checkbox"/> 39cm	<input type="checkbox"/> 41,5cm	<input type="checkbox"/> 44cm	<input type="checkbox"/> 46,5cm	<input type="checkbox"/> 49cm	<input type="checkbox"/> 51,5cm
Standard	Standard	Standard	Standard	Standard	On Request	On Request	On Request
Art : 800-40134	Art : 800-40136	Art : 800-40139	Art : 800-40141	Art : 800-40144	Art : 800-40146	Art : 800-40149	Art : 800-40151

## Frame length (J)

<input type="checkbox"/> 31cm	<input type="checkbox"/> 34cm	<input type="checkbox"/> 40cm
Recommended seat depth 37,5 - 42,5cm	Recommended seat depth 42,5 - 50cm	Recommended seat depth 45 - 50cm
Art : 800-40034	Art : 800-40040	Art : 800-40045





## Frame Colour

<input type="checkbox"/> Antracite	<input type="checkbox"/> White RAL 9016	<input type="checkbox"/> Blue RAL 5002	<input type="checkbox"/> Black RAL 9005	<input type="checkbox"/> Red RAL 3003	Special - Uni	Special
Standard	Standard	Standard	Standard	Standard	€ 90	On request
					Always refer to desired RAL colour through <a href="http://www.ralkleuren.com">www.ralkleuren.com</a>	
Art : 800-40310	Art : 800-40330	Art : 800-40335	Art : 800-40340	Art : 800-40340	Art : 800-40350	Art : 800-40300

## Camber (X)

<input type="checkbox"/> 0°	<input type="checkbox"/> 3°	<input type="checkbox"/> 6°	<input type="checkbox"/> 9°
Standard	Standard	€ 100	€ 172
Art : 800-40400	Art : 800-40403	Art : 800-40406	Art : 800-40409

## Footrest (U) (foot space = Seatingwidth - 13cm)

<b>Set</b> <input type="checkbox"/> 	<b>Set</b> <input type="checkbox"/> 	<b>Left</b> <input type="checkbox"/> 	<b>Right</b> <input type="checkbox"/> 
<b>Folding 2 pieces</b>	<b>Folding 1 piece</b>	<b>Comfort-leg rest</b>	
Legrest, lower leg length adjustable, removable, swing away with angle adjustable foot plates	Legrest, lower leg length adjustable, removable, swing away	Legrest, lower leg length adjustable, removable, swing away with angle adjustable foot plate	
Standard	€ 227	€ 205	€ 205
Art : 800 - 30000	Art : 800 - 30600	Art : 800-31010	Art : 800-31020

## Footplate (only in combination with folding 1 piece)

<input type="checkbox"/> 	<input type="checkbox"/> 	<input type="checkbox"/> 	<input type="checkbox"/> Custom made	<input type="checkbox"/> Custom made
Standard ( 23 x 12 cm ) Aluminum	Wide ( 29 x 12 cm ) Aluminum	Deep ( 23 x 19 cm ) Aluminum	Aluminum	Plastic
from seat width 39 cm	from seat width 44 cm	from seat width 39 cm	commissioned after drawing	
Standard	€ 68	€ 68	On request	
Art : 800 - 38009	Art : 800 - 38010	Art : 800 - 38040	Art : 800 - 3801 x	Art : 800 - 3802 x

## Seat depth

<input type="checkbox"/> 35cm	<input type="checkbox"/> 37,5cm	<input type="checkbox"/> 40cm	<input type="checkbox"/> 42,5cm	<input type="checkbox"/> 45cm	<input type="checkbox"/> 47,5cm	<input type="checkbox"/> 50cm
Only in combination with RCA 1.0						Not in combination with RCA1.5
Art : 800-40535	Art : 800-40537	Art : 800-40540	Art : 800-40542	Art : 800-40545	Art : 800-40547	Art : 800-40550

## Seating

<input type="checkbox"/>	<input type="checkbox"/>	<input type="checkbox"/>	<input type="checkbox"/>
Flat seat, harness, Cordura, for inlaycushion	Flat seat, expended metal, not in combination with RCA 1.0. For inlaycushion	Seating flat with Seat-E-Lastica; not in combination with RCA 1.0	Ergonomic contour seat cushion, padded
Standard	€ 527	€ 290	€ 482
Art : 100-140 x x	Art : 100-133 x x	Art : 100-142 x x	Art : 100-122 x x

## Cushion

<input type="checkbox"/>	<input type="checkbox"/>	<input type="checkbox"/>
		Custom made
Cushion medium	Cushion Soft	commissioned after drawing
6cm foam	3 cm latex (upper layer) 2 cm foam (lower layer)	
€ 94	€ 165	On request
Art : 100-412 x x	Art : 100-411 x x	Art : 100-413 x x

## Backrest hinge

<input type="checkbox"/>	<input type="checkbox"/>	<input type="checkbox"/>
Basic	RCA 1.0	RCA 1.5
Back Foldable back angle mechanically adjustable	Backrest-hinge centered	Backrest-hinge 2,5 cm rearpositioned
(adjustment range 85 to 115 °)	By user manually per 3 ° adjustable (adjustment range 0 - 85 to 115 °) RCA = Remote Continuous Adjustable	
Standard	€ 432	€ 495
Art : 100-38000	Art : 100-32000	Art : 100-36000

<input type="checkbox"/>
Reinforced RCA 1.0 (spasm)
Backrest-hinge centered
On request
Art : 100-32000

## Backrest shape

<input type="checkbox"/>	<input type="checkbox"/>	<input type="checkbox"/>	<input type="checkbox"/>
Straight	Ergonomic, anatomic backrest height from 40cm	Backrest for women, ergonomic, anatomic backrest height from 40cm	Backrest shape 'Delta', only with seating width 39cm/41,5cm/44cm
Standard	€ 393	€ 495	€ 495
Art : 100-225 x x	Art : 100-200 x x	Art : 100-220 x x	Art : 100 - 240 x x

## Backrest height

<input type="checkbox"/>	<input type="checkbox"/>	<input type="checkbox"/>	<input type="checkbox"/>
Height 35cm	Height 40cm	Height 45cm	Height 50cm
Art : 800-42135	Art : 800-42140	Art : 800-42145	Art : 800-42150

## Backrest height Delta Backrest

<input type="checkbox"/>	<input type="checkbox"/>
Height 60cm	Height 70cm
Art : 800-42160D	Art : 800-42170D

## Backrest cover Colour





<input type="checkbox"/>	<input type="checkbox"/>	<input type="checkbox"/>	<input type="checkbox"/>	<input type="checkbox"/>	<input type="checkbox"/>	<input type="checkbox"/>
						Spare cover
Orange	Red	Black	Blue	Dark Blue	Silver	Colour:
Standard	Standard	Standard	Standard	Standard	Standard	€ 91
Art : 100-400 x x	Art : 100-401 x x	Art : 100-402 x x	Art : 100-403 x x	Art : 100-405 x x	Art : 100-406 x x	Art : 100-400 x x

## Wheel diameter

Possible seat height technical measure sheet

<input type="checkbox"/> 22" x 1 - ( 25 - 489 )	<input type="checkbox"/> 24" x 1 - ( 25 - 540 )
€ 76	Standard
Marathon Plus Evolution tires	
Only in combination with 4 inch castors	
Art: 800-41022	Art: 800-41024

## Rear wheel (set, with Quick Release)

Set <input type="checkbox"/>		Set <input type="checkbox"/>		Set <input type="checkbox"/>		Set <input type="checkbox"/>	
			Rear wheel with drumbrake (with black rim) only in 24", push handle recommended		Rearwheel with Edco hub-lock		Reinforced
Standard		€ 1.018		€ 190		€ 356,40	
Art : 800-41024		Art : 991 - 42 x x x		Art : 991 - 2 x 101		Art : 991 - 2 X 202	

## Lightweight

<input type="checkbox"/>	<input type="checkbox"/>	<input type="checkbox"/>
Lightweight Spinergy-wheels	Lightweight Tensio-wheels	Heavy Duty Tensio wheels
Set	Set	Set
On request	On request	On request
Art : 991 - 43 x x x	Art : 991 - 455 0 x	Art : 991 - 455 1 x

## One hand drive

Drive Left <input type="checkbox"/>		Drive Right <input type="checkbox"/>
One hand drive - seat height 2 cm higher (front and back) not possible with 6° - 9° camber, only in 24"		
€ 1.363		
Art : 991 - 41 x x x		







## Rear tire

<input type="checkbox"/>	<input type="checkbox"/>	<input type="checkbox"/>	<input type="checkbox"/>	<input type="checkbox"/>
				
Schwalbe Marathon Plus Evolution	Solid - PU	Schwalbe Right Run Red	Schwalbe Right Run Blue	Schwalbe Right Run Grey
Standard	€ 85	€ 0	€ 0	€ 0
Art : 991-67 x 01	Art : 991-67 x 11	Art : 991-67 X 21	Art : 991-67 X 22	Art : 991-67 X 23

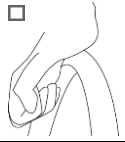

## Alber drives

<input type="checkbox"/>	Alber-drive construction is possible
	Delivery by dealer - O4 Frame adaptation - € 104,-





## Handrim (set)

<input type="checkbox"/>	<input type="checkbox"/>	<input type="checkbox"/>	<input type="checkbox"/>	<input type="checkbox"/>	Left <input type="checkbox"/>	Right <input type="checkbox"/>	Handrim distance to wheelrim	
							<input type="checkbox"/>	<input type="checkbox"/>
Aluminium	TETRA	PARA	ERGO	Stainless steel	Handrimcover (1 piece)	Handrimcover (1 piece)	Narrow	Wide
	Handrim with extra gripp	Handrim with extra gripp	Handrim with extra gripp					
Standard	€ 430	€ 430	€ 468	€ 245	€ 88	€ 88	Standard	Option without costs
Art : 800-62x11	Art : 800-62x01	Art : 800-62x02	Art : 800-62x03	Art : 800-62x12	Art : 991-61x01	Art : 991-61x01	-	-

## Spoke guard (set)



<input type="checkbox"/>		<input type="checkbox"/>	
Transparant		O4-logo	
€ 120		€ 100	
Art : 991 - 60 x 01		Art : 991 - 60 x 02	





## Wheel lock





<input type="checkbox"/> Left	<input type="checkbox"/> Right	<input type="checkbox"/> Links	<input type="checkbox"/> Right	<input type="checkbox"/> Left	<input type="checkbox"/> Right	<input type="checkbox"/> Left	<input type="checkbox"/> Right
							
Pull lock (pull to lock)		Push lock (push to lock)		Long push lock, folding (push to lock)		One-hand wheel lock (push to lock)	
Standard		Standard		€ 58	€ 58	€ 290	
Art : 800-47103	Art : 800-47203	Art : 800-47104	Art : 800-47204	Art : 800 - 07105	Art : 800 - 07205	Art : 800-47110	

## Castor wheels (set)





For possible seating heights, we refer to our technical measuring sheet

<input type="checkbox"/>	<input type="checkbox"/>
	
Soft 6" Synthetic	Super Soft 6" with wide running surface
€ 22	€ 296
Art : 800 - 06001	Art : 800 - 06004





<input type="checkbox"/>	<input type="checkbox"/>	<input type="checkbox"/>	<input type="checkbox"/>
			
Soft 5" Synthetic	Hard 5" Synthetic	Hard 5" Aluminum	Super Soft 5" Synthetic with wide running surface
Standard	€ 15	€ 115	€ 260
Art : 800 - 05001	Art : 800 - 05002	Art : 800 - 05003	Art : 800 - 05004

<input type="checkbox"/>	<input type="checkbox"/>	<input type="checkbox"/>	<input type="checkbox"/>
			
Soft 4" Synthetic	Hard 4" Synthetic	Hard 4" Aluminum	Super Soft 4" Synthetic with wide running surface
€ 22	€ 25	€ 90	€ 260
Art : 800 - 04001	Art : 800 - 04002	Art : 800 - 04003	Art : 800 - 04004



## Anti-tip

<input type="checkbox"/> Left	<input type="checkbox"/> Right	<input type="checkbox"/> Left	<input type="checkbox"/> Right	<input type="checkbox"/> Left	<input type="checkbox"/> Right	<input type="checkbox"/> Left	<input type="checkbox"/> Right
							
Anti-tip height adjustable		Anti-tip - 360° revolving (one-sided fit)		Tip-assist (step tube) - fixed (not in combination with 2 anti-tip wheels)		Crutch holder	
€ 128	€ 128	€ 184	€ 184	€ 82	€ 82	€ 78	€ 78
Art : 800 - 44000	Art : 800 - 45000	Art : 800-44010	Art : 800-45010	Art : 800-43200	Art : 800-43700	Art : 800-43210	Art : 800-43710



## Side guard

<input type="checkbox"/> 	<input type="checkbox"/> 	<input type="checkbox"/> 	<input type="checkbox"/> 	<input type="checkbox"/> 
<b>Sideguard, fixed, no fender</b> Only in combination with seat 'Cordura' and backrest hinge 'Basic'	<b>Side guard, removable, no fender.</b> Only in combination with armrests	<b>Side guard, fixed without fender, aluminum</b>	<b>Side guard, fixed with fender, aluminum</b>	<b>Side guard, fixed with fender, carbon</b>
€ 0,-	€ 96	€ 96	€ 244	€ 322
Art : 100 - 96070	Art : 100 - 96030	Art : 100 - 96040	Art : 100 - 96050	Art : 100 - 96010





## Arm rests





<input type="checkbox"/> 	<input type="checkbox"/> 
<b>In height adjustable armrest, removable, angle fixed.</b> Only when combined with Side guard fixed with fender, only carbon, the side guard will be adjusted. (additional cost)	<b>In height adjustable armrest, removable, angle adjustable</b> Only when combined with Side guard fixed with fender, only carbon, the side guard will be adjusted. (additional cost)
€ 330	€ 420
Art : 100 - 96110	Art : 100 - 96170

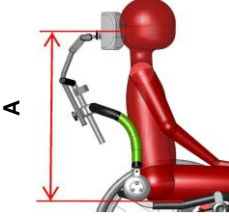

## Arm cushioning (in combination with angle adjustable arm rest)





<input type="checkbox"/> 	<input type="checkbox"/> 	<input type="checkbox"/> 	
<b>Hemiplegic-arm cushioning</b> (piece)	<b>Arm cushioning long</b> (piece) (Length as standard + 10cm)	<b>Custom made</b>  commissioned after drawing	
€ 205	€ 205	€ 75	€ 75
Art : 100 - 96140	Art : 100 - 96240	Art : 100 - 96180	Art : 100 - 96280
		On request	On request
		Art : 100 - 96130	Art : 100 - 96230

## Accessories

<input type="checkbox"/> 	<input type="checkbox"/> 		<input type="checkbox"/> 	<input type="checkbox"/> 
<b>Push handle</b> , in height adjustable and removable	<b>Headrest</b> , in height adjustable and removable (Indicate measure A)		<b>Rising support for the back</b> <i>Not mounted</i>	
€ 225	€ 237		€ 98	€ 196
Art : 100 - 210 x x	Art : 100 - 230 x x	<b>A (cm) =</b>	Art : 100 - 47010	Art : 100 - 47020

<input type="checkbox"/> 	<input type="checkbox"/> 	<input type="checkbox"/> 	<input type="checkbox"/> 
<b>Sidepad small 10x12 cm</b> possible from backheight 45 cm. <i>Not mounted</i>	<b>Sidepad small 14x14cm</b> possible from backheight 45 cm. <i>Not mounted</i>	<b>Tensionstrap for back, adjustable, out of Seat-E-Lastica, 5 cm wide</b> <i>Not mounted</i>	<b>Tensionstrap for back, adjustable, out of Seat-E-Lastica, 10 cm wide</b> <i>Not mounted</i>
€ 288	€ 308	€ 62	€ 124
Art : 800-01102	Art : 800-01202	Art : 100 - 46001	Art : 100 - 46002
		Art : 100 - 46011	Art : 100 - 46012

<input type="checkbox"/> 	<input type="checkbox"/> 
<b>Incontinence cover</b>	<b>Extra Seating cover</b>
€ 103	€ 103
Art : 100 - 112 x x	Art : 100 - 111 x x

<input type="checkbox"/> 	<input type="checkbox"/> 	<input type="checkbox"/> 	<input type="checkbox"/> 
<b>Calf band</b>	<b>College-worktop</b>	<b>Safety belt</b>	<b>Purse under the seat</b>
€ 34	On request	€ 92	€ 84
Art : 800 - 01001	Art : 800 - 01003	Art : 800 - 01002	Art : 800 - 01010

All our deliveries are subject to the General Conditions for the Supply of Mechanical, Electrical and Electronic Products (Orgalime S2000) as published by the Orgalime, The European Engineering Industries Association. Order form January 2014 (Specifications are subject to change without notice)  
 Wheelchairs T: +31 (0) 315 396 900 Markenweg 9, 7051 HS Varsseveld, Netherlands F: +31 (0) 315 396 909 E: info@o4.eu I: www.o4.eu