

eFOLDi Scooter

Model: Lite



USER MANUAL

eFOLDi[®] 



PLEASE NOTE:

The different colours of the eFOLDi scooter and its accessories displayed in this user manual are for clear demonstration purpose only. Your eFOLDi will not have the same colour combination as in the manual.

Contents

■ Terms, conditions and disclaimers _____	2
■ Welcome _____	4
■ Product overview _____	6
■ Components _____	7
■ Safety guidance _____	8
■ Unfolding instructions _____	10
■ Folding instructions _____	12
■ How to drive your eFOLDi _____	14
■ Battery info and charging _____	16
■ Checks and maintenance _____	19
■ Frequently asked questions _____	20
■ Technical specifications _____	22

Terms, conditions and disclaimers

The terms 'us', 'we', 'our', 'SunTech UK' and SunTech UK Ltd' mean SunTech UK Limited, which is a UK registered company, limited by guarantee, registered with Companies House, number 06906908. The terms 'website' means the website found online at 'www.eFOLDi.co.uk' and/or 'www.eFOLDi.com'. The terms 'you', 'your', 'user' and 'rider', mean the person using the eFOLDi notwithstanding any person(s) handling the eFOLDi on behalf of the user, if different to the user, including general handling, maintenance, repairs and so on.

PURCHASER'S AGREEMENT

By accepting delivery of this eFOLDi, you undertake to not change, alter or modify this eFOLDi and/or any parts supplied with it or subsequently for it, and/or render inoperable or unsafe, any guards, shields or other safety features of this product; fail, refuse or neglect to install any retrofit kits from time to time, as may be provided by SunTech UK Ltd to enhance and/or preserve the safe use of this product. You also agree to accept and abide, by/with the terms and conditions contained herein and as may be revised from time to time and updated on our website, being immediately applicable. By using the eFOLDi and/or accessories and/or components supplied with or for the eFOLDi, the user acknowledges having read and understood the use(s) and limitations of the product(s) without exceptions. This shall not act as a waiver of any implied warranties, which customer retains, as provided by law.







Warranties will be void and SunTech UK Ltd will accept no responsibility whatsoever or howsoever, in instances of misuse and/or abuse of the products, in part or in full, by the user and/or any unauthorised persons, which may include (but not to be limited to); the user(s) failing to comply with all legal requirements and guidelines, wherever and/or however it is used or intended to be used, lack of or inappropriate maintenance, maintenance (apart from the routine maintenance as described in this manual by the user) by anyone not approved to do so, unapproved repairs, unauthorised disassembly of the vehicle and/or components including (but not limited to) battery pack(s) and controllers, unapproved modifications or alterations, failure to ensure correct folding and unfolding procedures are followed precisely and in full, damage or injury howsoever caused, failure to apply all reasonable and appropriate safety precautions at all times, improper use of the vehicle and/or parts and/or accessories, being used by more than one person at any times, use in any competitive sport, racing, stunts, jumping or other similar activity.

Our liability and the liability of our suppliers, to you or any third parties in any circumstances is limited to the user's cost of qualifying products purchased. Qualifying products as acceptable for the return, as outlined in the returned policy, as stated on the website online at: www.eFOLDi.co.uk and/or 'www.eFOLDi.com'.

Information in this user manual is subject to change without prior notice. For the latest updates and information, please go to our website online at: www.eFOLDi.co.uk and/or 'www.eFOLDi.com'.

THE eFOLDi Lite SHOULD NOT BE USED BY

PEOPLE WHO ARE UNABLE TO:

-  Fold or unfold it using both hands.
Unless accompanied by a person sufficiently able and competent to carry out that task.
-  Transfer themselves onto the seat and remain in a seated upright position at all times, without assistance while the vehicle is in motion.
-  Place and keep both feet on the footrest.
-  Operate all controls fully and as intended.
-  Steer competently and control speed, appropriately at all times and in all conditions.
-  Maintain appropriate awareness of all relevant circumstances for each journey and take appropriate action as may be required to avoid mishap.
-  Lift it in whole or in part as may be required dependent upon user's needs.
Unless accompanied by a person sufficiently able and competent to carry out that task.

SHIPPING AND DELIVERY

Before using your eFOLDi , make sure your delivery is complete as some components may be individually packaged. If you do not receive a complete delivery, please contact us immediately. Where damage has occurred during transport, either to the packaging or the content, please contact the delivery company responsible.

Welcome



Thank you for choosing an eFOLDi scooter as your mobility solution.

I'm Sumi Wang, the founder of Suntech UK and co-inventor of the eFOLDi and would like to welcome you to the eFOLDi family of users.

Suntech UK manufactures a range of assistive technologies to help you get the most from life. Our mission is to give our customers freedom, friendship and fun with a range of easy to use, convenient and market leading mobility solutions.

Your eFOLDi has been manufactured to the highest standards and quality checked by our own pre-sales technicians before delivery to provide you with a product that will give many years of freedom and fun with reliable service.

Please take some time to read the user manual and the supplied documents before using your eFOLDi for the first time, this will help you understand the product and help you obtain maximum enjoyment and safety from your new eFOLDi scooter. You will quickly become familiar with the features of your eFOLDi with a little practice.

Suntech UK prides itself on its high-quality products and customer support so please remember to return the warranty form and retain all of the supplied documents in a safe place. These will help us to assist you in the event of any difficulties you may experience in the future.

I am sure you will find your eFOLDi scooter to be a reliable friend and companion and I thank you for your custom and your trust in our products.

Yours,

A handwritten signature in blue ink that reads 'Sumi Wang'.

Sumi Wang

Useful Information for you

Website address	www.efoldi.com
Email	services@efoldi.com
Facebook	www.facebook.com/efoldi.co.uk



Product overview

Storage mode



Trolley mode



eFOLDi Lite is the worlds lightest, most compact, folding mobility scooter. Weighing only 15 Kg and no larger than a small suitcase when folded. Amazingly easy to set-up and fold - fully airline compliant, eFOLDi Lite is the perfect super lightweight travel companion.

Scooter mode



Model: Lite

Components

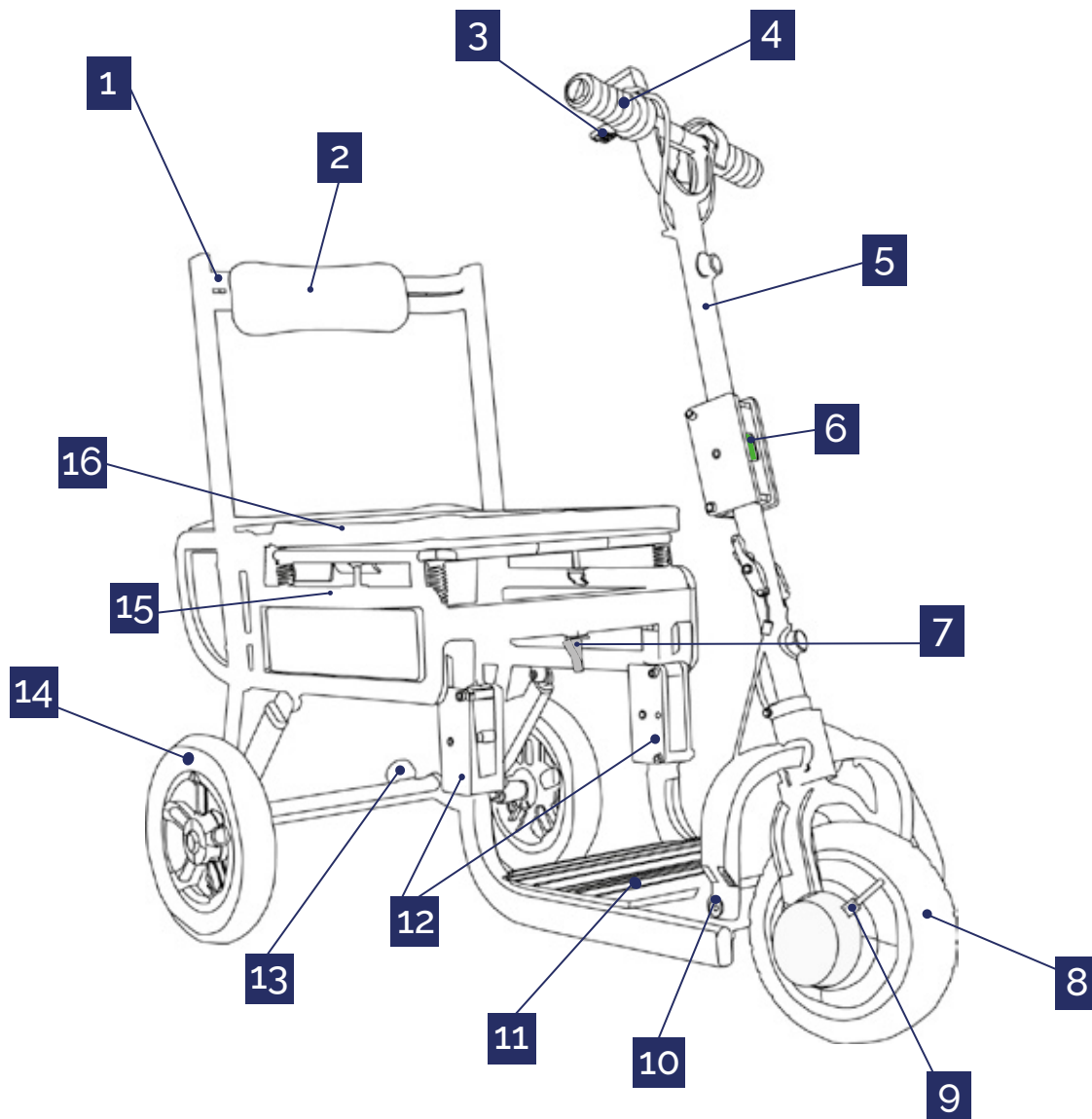

PARTS LIST

1	Backrest frame	9	Front brake lock lever
2	Backrest	10	Hinge to fold front wheel
3	Accelerator/electric brake lever	11	Footrest
4	Handle bar	12	Hinge to fold footrest
5	Steering column	13	Suitcase wheels
6	Lever for steering column	14	Rear wheels
7	Latch	15	Main frame
8	Front wheel	16	Seat

Safety guidance

- It is the users responsibility to read the manual and supplied documents before using the eFOLDi and to follow all of the recommendations contained within, to fully comply with all local laws of their countries and localities and to use the eFOLDi with due diligence and regard to other road users and pedestrians.
- The eFOLDi is simple to use but its folding mechanism can cause significant injury if used inappropriately and handled without due care and diligence. To avoid any risk of injury ensure hands, fingers, jewellery, clothing and other objects are not allowed to interfere with the folding mechanism or moving parts of the eFOLDi and study the manual carefully before you start operating your eFOLDi.
- It is advised that the user familiarise themselves with the folding and unfolding procedure before venturing outside. The user should also ensure that they familiarise themselves with the controls and handling of the scooter in a safe area away from obstacles and other pedestrians or road users.
- eFOLDi users are recommended to wear appropriate clothing when using a mobility scooter which should include an approved helmet, sturdy shoes or boots, appropriate gloves and high visibility protective clothing as a safety precaution.
- Fully charge the battery(ies) before first use and follow the guidelines in this manual for prolonging the life of your battery.
- Your eFOLDi Lite should only be stood on its main rear wheels and suitcase wheels when it is on level and stable ground.

CAUTION



When travelling at speeds greater than a slow walking pace be sure to slow down before turning.

Do not ride over rough, cobbled, muddy or loose gravel surfaces. Your eFOLDi is designed for smooth and firm footpaths, roads and pedestrian areas only.

Approach kerbs (maximum height of 3cm) carefully and at right angles and cross them slowly.

Any vehicle can be dangerous to its rider/driver and other road users and pedestrians. Always ride/drive responsibly, respectfully and with due care to others.

Your eFOLDi Scooter is NOT a toy and is not recommended for people under the age of 14. Do not allow children to play with or on the scooter. The internal folding mechanism can cause injury to small hands.

When unfolding/folding your eFOLDi Lite ensure:

- The eFOLDi is positioned on a level floor or ground,
- Main switch is switched off.
- All latch pins are properly secured in place, as stated on the instructions and shown on the illustrations.

Safety check before use

It is highly recommended that you perform a safety check before each use to make sure your eFOLDi operates smoothly and safely.

Check for correct tyre inflation. Maintain but do not exceed the PSI/BAR/kPa air pressure rating indicated on the pneumatic rear tyres and be sure to use the correct pressure scale and according number on your inflator/taster. ✓

Check all electrical connections. Make sure they are secure and not corroded. ✓

Check and test the brake system. ✓

Check frequently for any loose fasteners, fixings and other components. ✓

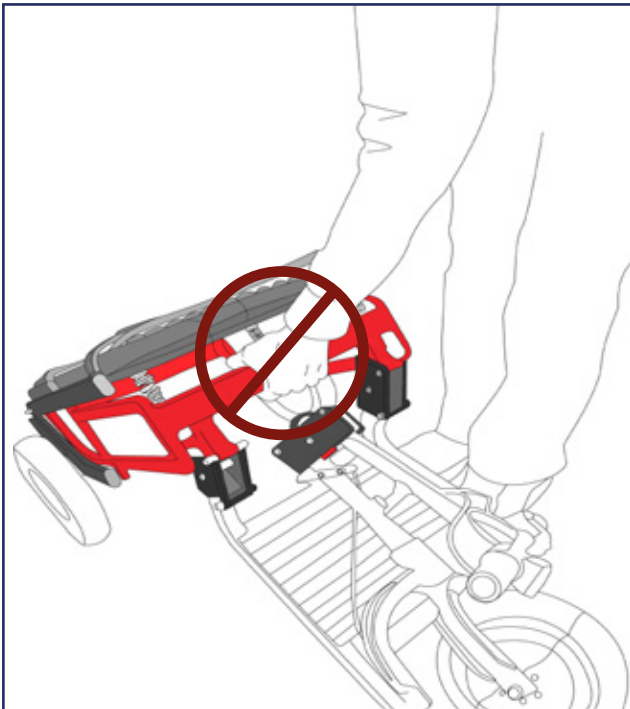

CAUTION



DO NOT for any reason put your hands into the main red frame of the eFOLDi Lite, especially in the last step of the folding process. This is because your hands and fingers can get trapped in the main levers and pivots and serious injuries can be caused.

DO NOT RUSH WHEN FOLDING OR UNFOLDING THE eFOLDi Lite.



Unfolding instructions

STEP 1:

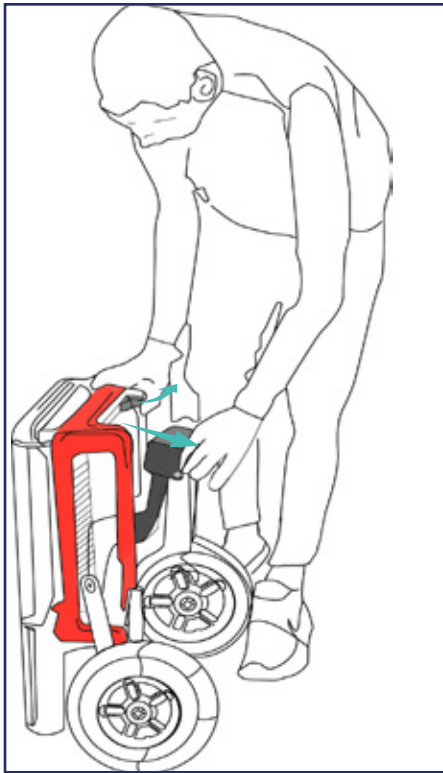

1. Position the eFOLDi Lite vertically and release the handle bar, by pressing the lock. Gently push the handle bar column forward.

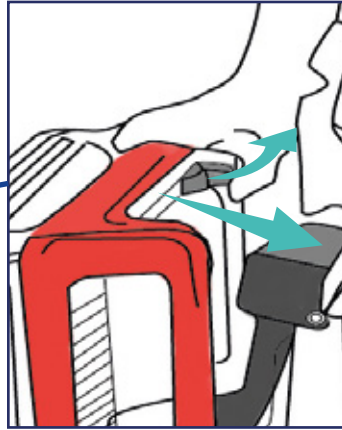

STEP 2:

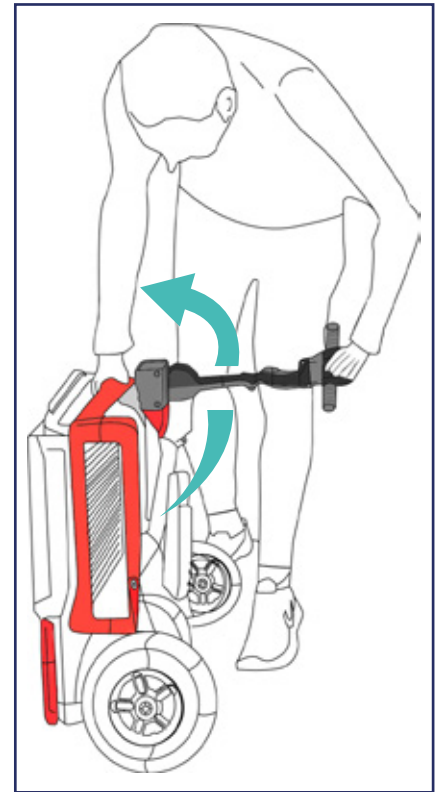

2. Grab the handle bar from the bottom and turn it 180° degrees vertically, making the column straight.

STEP 3:

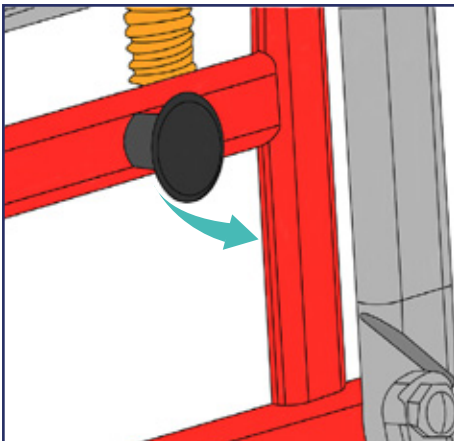

3. Pull the black knob, on the side of the frame, this will release the footrest and the front wheel.

STEP 4:

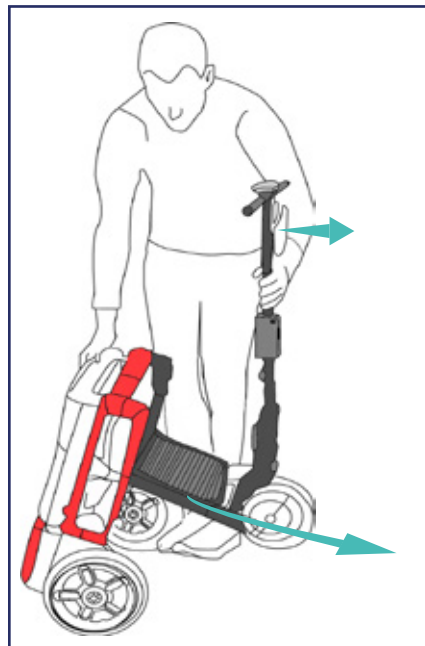

4. Firmly, hold the front steerer column and the backrest top of the scooter, and then push the column forward setting the front wheel on the ground and the footrest on a horizontal position.

Unfolding instructions

STEP 5:

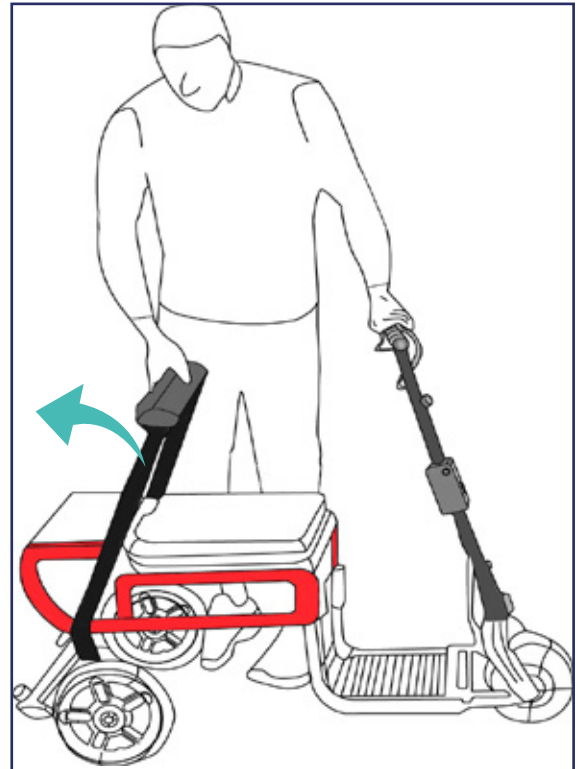
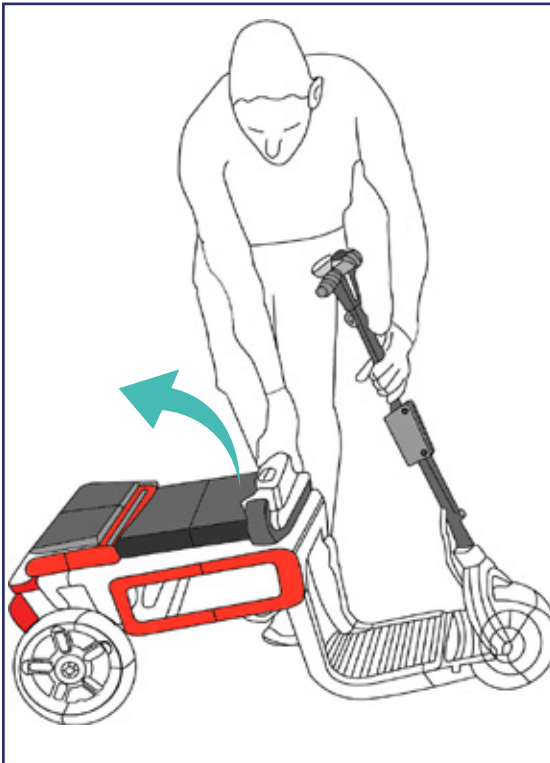

5. Grab the backrest section of your eFOLDi and pull it all the way backwards, until it's stable.





Folding instructions

STEP 1:

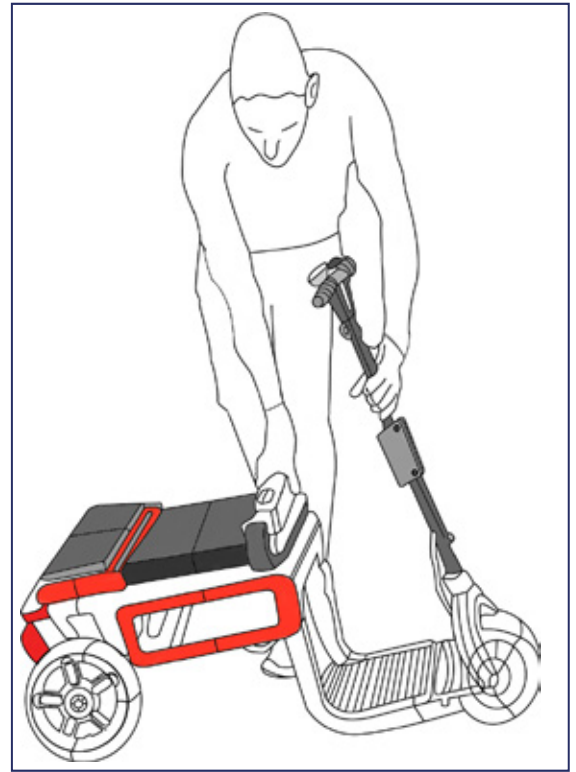
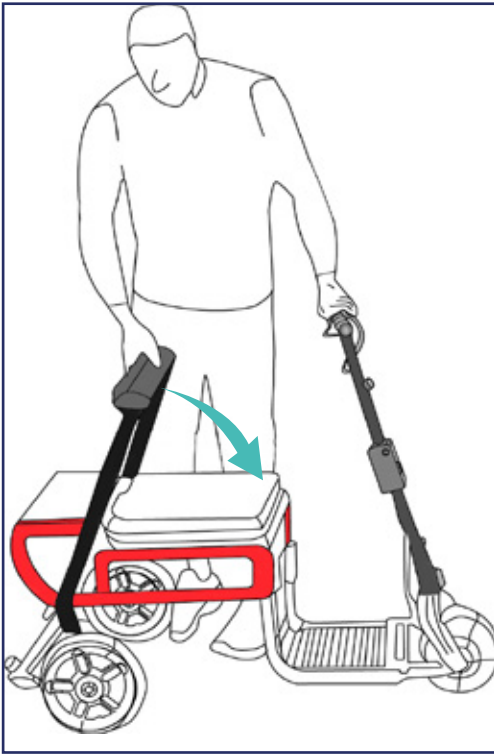

1. Push and fold the backrest on top of the seat.

STEP 2:

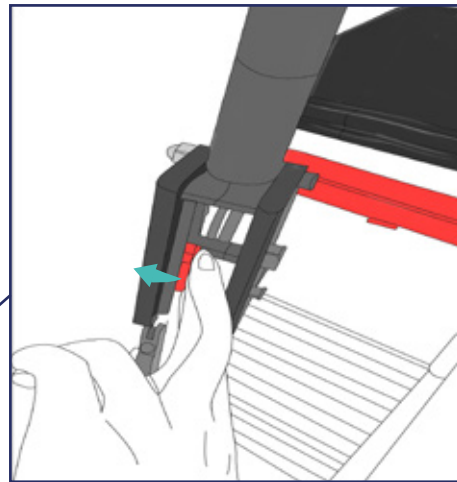
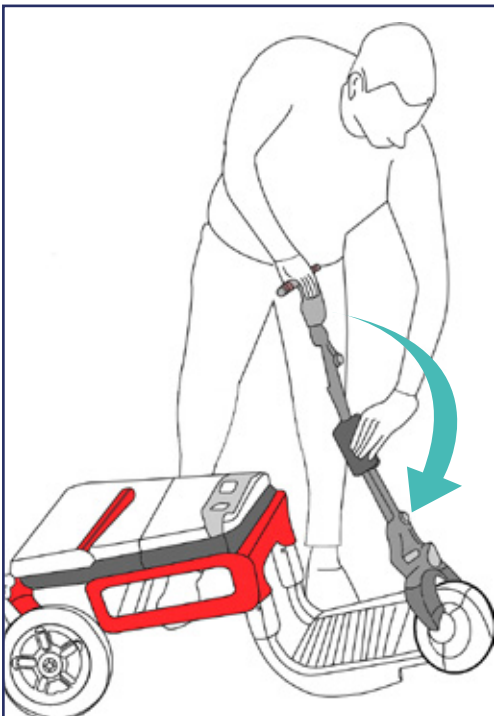

2. Push the lever on the middle rectangular section of the steerer column and fold it in half, in a 180° degrees clockwise rotation.



Folding instructions

STEP 3:

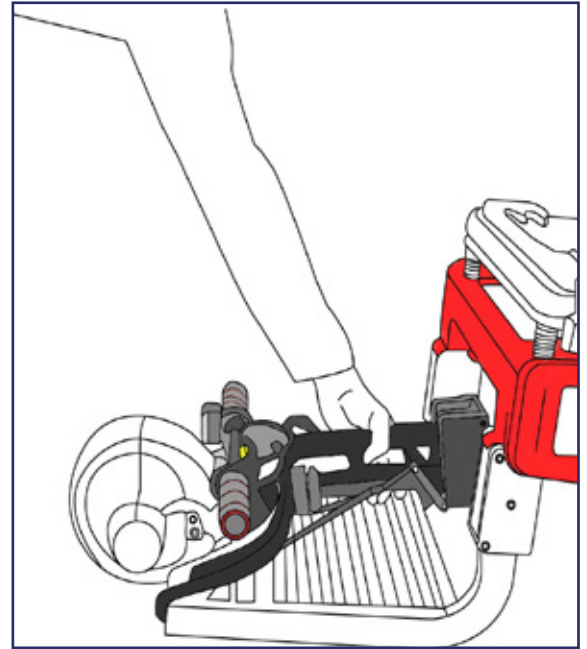
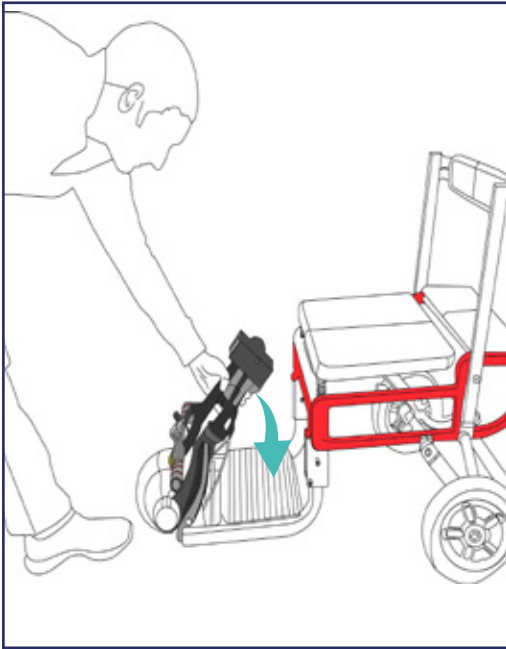

3. Place the folded handle bar on top of the footrest.

STEP 4:

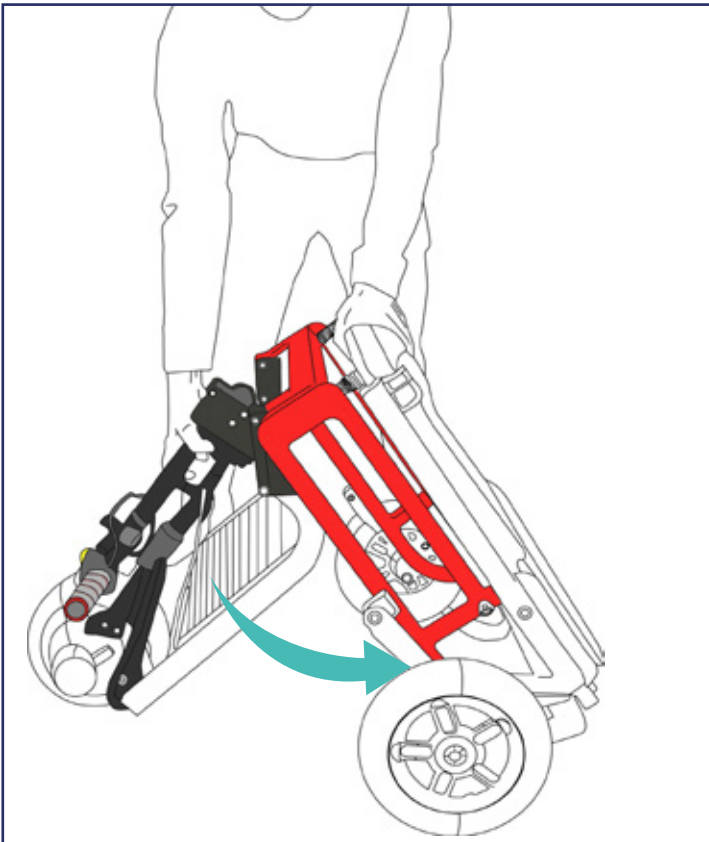

4. Finally, by standing on the side of the eFOLDi, bring it up into a vertical position, grab the handle and push the handle bar into the main frame until it locks in and it clicks.

How to drive your eFOLDi

The eFOLDi is designed to drive on smooth even surfaces. Unevenly paved roads or paths, potholes and other hazards, will reduce the life of any scooter and your safety.

The amount of charge remaining in the battery immediately before commencing any slope upward will be crucial to the climbing ability. Any deviation from level/horizontal surfaces should not exceed the level 1:6 (9.5 degrees, this is just a gentle slope) gradient of steepness. **For any climbing there are factors that need to be considered and these are: the tyre pressure and condition, the surface condition (if wet, icy or slippery, and this includes leaf cover and/or other debris, we advise against driving the slope), battery charge and the weight of the user, all of these will affect performance.**



Before driving your eFOLDi make sure

- You have read the safety guidance on page 8
- You have engaged the front brake lock lever

FRONT BRAKE LOCK LEVER

Front Brake Lock Lever: Must be in the forward, locked position to engage motor and operate throttle (picture – below left)

To disengage front brake lock, move lever out and rearwards (picture – below right). This will disengage motor and allow Efoldi to freewheel for manoeuvring by hand. If the eFOLDi is switched on there will be a continual warning sound from the bleeper.

DO NOT DISENGAGE BRAKE LEVER WHILST ON HILLS OR SLOPING GROUND – YOU WILL HAVE NO FORM OF BRAKING AVAILABLE.



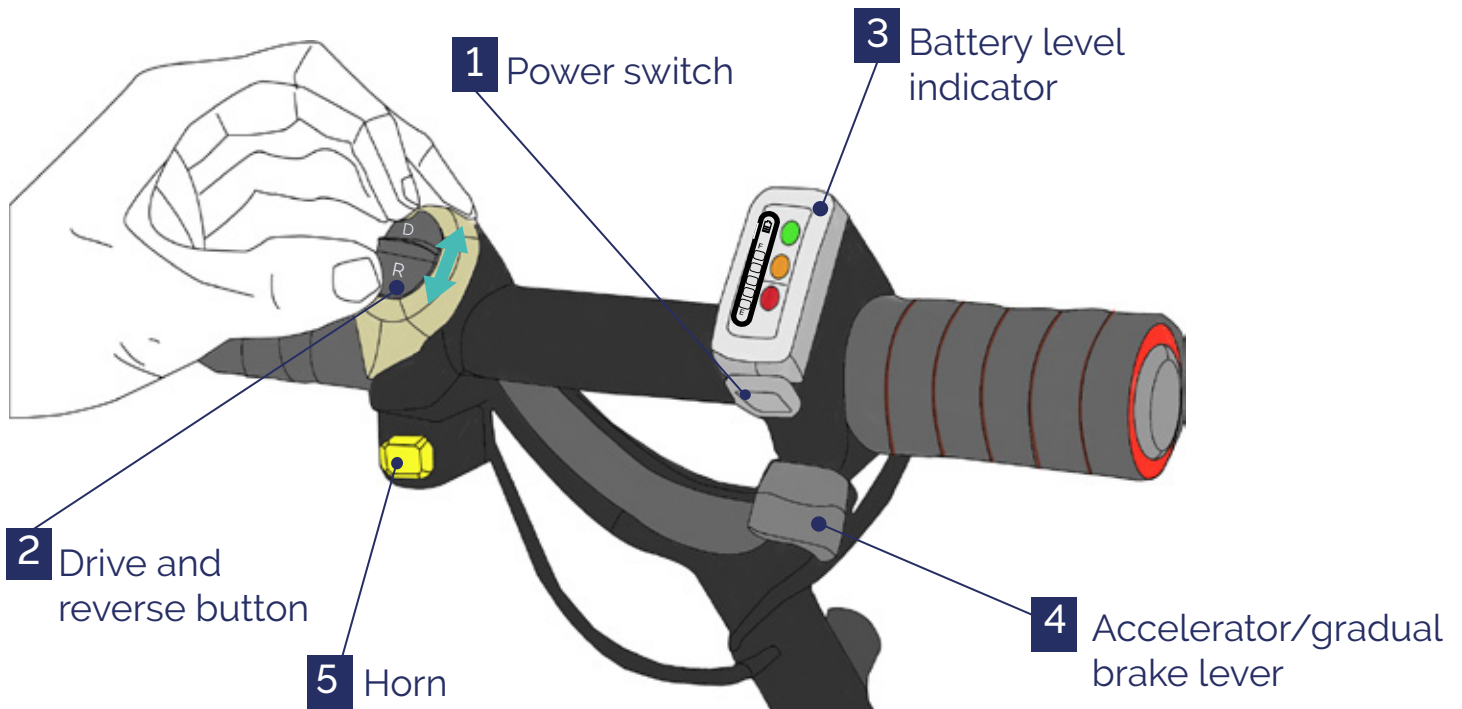

1 The power switch works by pushing the button underneath the battery level indicator.

2 The drive and reverse button works by pushing the button forward into the D position to drive. To reverse slide it backwards into the R position.

3 The battery level indicator will show you how much battery there is left for usage. When the battery is fully charged all three lights will illuminate. When the red light is shown the battery will soon need charging.

4 The accelerator/gradual brake lever. As soon as the lever is pressed the vehicle will drive, reaching a maximum speed of 4mph. The braking system will work gradually, as soon as the lever is released.

5 The horn works by pressing the yellow button under the drive and reverse button.

Battery info and charging



The eFOLDi battery has been designed and built specifically for the eFOLDi Lite. This battery must not be used for any purpose other than as stated in this manual. Any misuse or dismantling of this battery may damage it physically and/or electrically, internally and/or externally and will not be covered by warranty. The battery contains no user serviceable or replaceable components.

The eFOLDi Lite battery is actually a battery pack, comprising a number of lithium/ion cells, but merely termed 'battery' for ease throughout this manual. This battery is different in characteristics and charging requirements to the old and still quite common lead/acid or lead/gel type. Never use a lead type charger to charge it.

To ensure best long-term use of the battery, please observe the following safety rules at all times

- Connection dock must be handled with care to avoid damage.
- Charge the battery only with the approved charger.
- Never use a charger for lead type batteries on the eFOLDi battery.
- Never place the battery near, on or against any heat source.
- Ensure no metal parts can touch (or 'short') battery or charger terminals, connectors, pins or any other electrical conductor(s) or conducting parts.
- Avoid excessive physical impact and vibration of the battery.
- Do not attempt to dismantle, dissect or deform the battery(ies) or case(s).
- Do not immerse the battery in any liquid (including water).
- Do not mix different types of batteries.
- Keep the battery out of reach of children.
- Do not use modified or damaged chargers.
- Do not leave the battery on charge for more than 24 hours.
- Store the battery in a cool, dry, well ventilated area
- Dispose of the battery only in accordance with local laws and regulations.
- If the battery is not used often, it is preferable to give it a short 'top up' charge every 2-3 months.



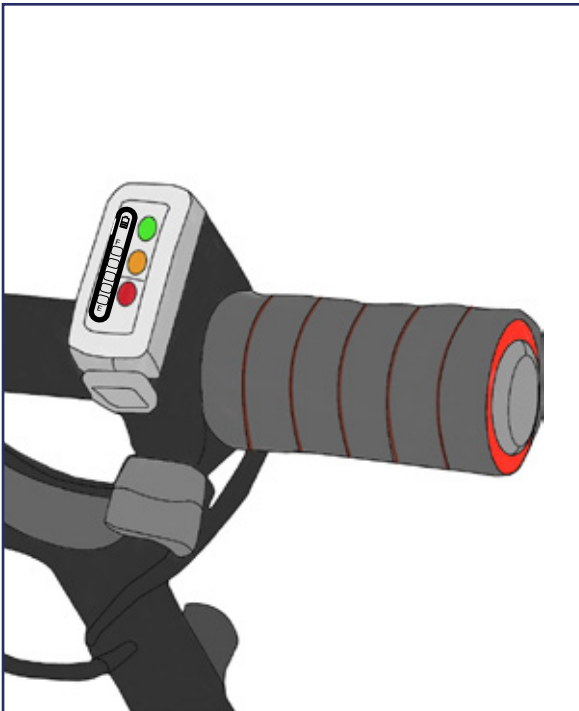

This is the battery level indicator, positioned on the handle bar. The indicator will show you, how much battery there will be left for usage.

Meaning of light indication on battery:

Green light: Battery is fully charged.

Orange light: A medium level of battery is available.

Red light: Battery will soon need charging.

Power and performance:

The eFOLDi Lite battery will have a maximum power of 24V to transfer to the motor, which it will power up to a 4mph speed for a range distance of 22 km for a full charge.

Battery removal and fitting

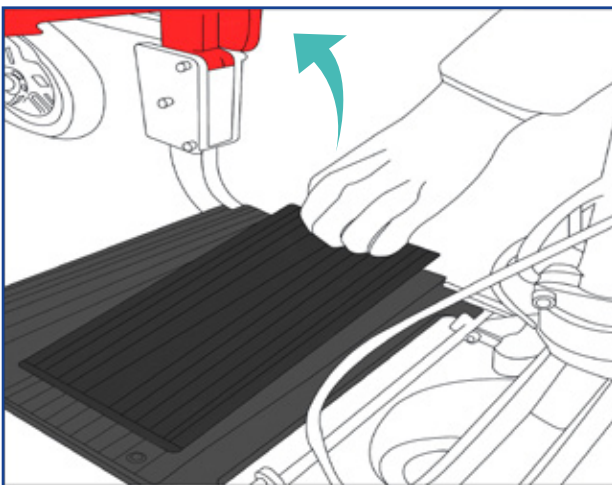

The battery is positioned in the footrest of the eFOLDi Lite.

To take out and charge the battery you have to press the release lock and it will be instantly disengaged.

Repeat the process in reverse making sure the battery clicks into place.

Charger and charging

Precaution for use and handling charger

Use only the charger originally supplied with your new eFOLDi or replacement charger supplied by SunTech UK Ltd for the use with the eFOLDi. The use of a non-approved charger will invalidate any warranty and may cause serious damage to the battery and/or your eFOLDi. The charger should not be used with or for other devices as damage caused to the charger and/or any other device by doing so will not be covered by our warranty.

It is highly recommended to ensure the charger is placed only on a heat resistant surfaces and nothing, which could contribute to a fire (e.g. carpet, floorboards, wood, laminate or plastic worktops and so on)- the charger will heat up during a normal charging cycle, as will the battery.

Do not leave the battery on charge for more than 24 hours as this will reduce the life and performance of the battery.

Charging notes for international travellers.

For the benefit of international travellers, your approved eFOLDi charger can be used with any mains voltage supply from 100 to 240 Volts, with a suitable travel adaptor.

Using the charger

*Before obtaining an alternative cable, it is recommended you examine your eFOLDi charger to determine which type of plug it requires - it will be either a two -pin 'figure of 8' (IEC60320-1 C7), or a three-pin similar to a kettle (IEC60320-1 C13).

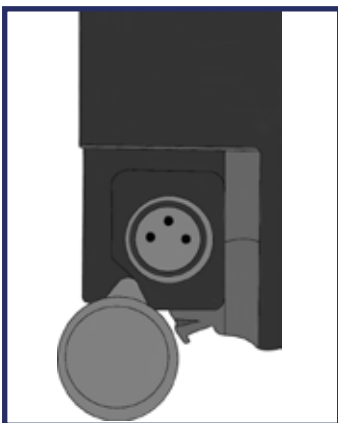

After the easy removal of the battery it can be charged up by plugging into the socket. The eFOLDi Lite will charge up in **5 hours and last for 14 miles/22 km of travel distance.**



- Make sure you don't put too much force on the steering column and handle bar, which may cause it to bend and lose steering efficiency.
- Keep clean and lubricate all moving and/or foldable parts
- Rear tyres should be checked for damage and inflated to 30 PSI for a comfortable ride.
- **Have your eFOLDi regularly serviced each year.**

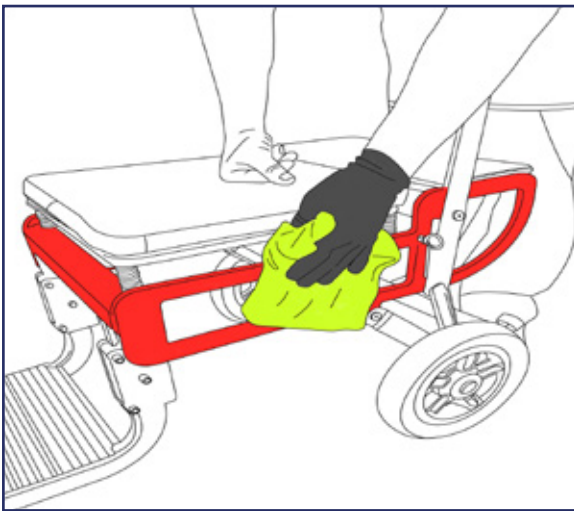

Wheel adjustments

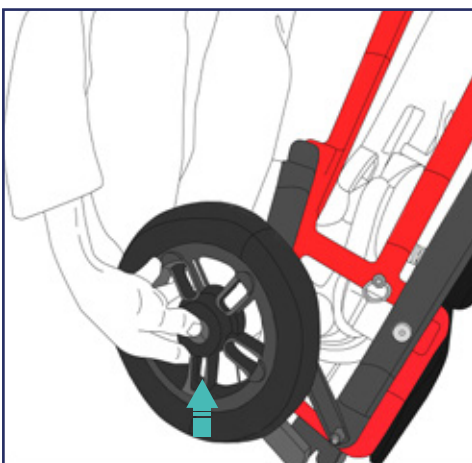

The rear wheels can be removed, by pressing the button directed by the arrow, this allows the wheel axle to dis-engage from the eFOLDi Lite's main frame.

To re-attach the wheel repeat the process in reverse and a click sound will be heard.

It is advised to give the wheel a spin to make sure it is locked-in and aligned properly.

Frequently asked questions



■ **How much does the eFOLDi Lite weight?**

The eFOLDi Lite weights 15 Kg /33lbs.

■ **How much weight can the eFOLDi Lite carry?**

The eFoldi Lite will carry up to 120kg/265lbs

■ **What tyre pressure do I need?**

The rear tyres require 30 PSI for a comfortable ride. The eFOLDi Lite has a solid front tyre.

■ **What size inner tubes will I need if I get a puncture?**

The rear tyres are 10" x 2"

■ **Is the handlebar height or seat adjustable?**

No, neither are adjustable.

■ **Where is the battery?**

The battery is fitted in the footrest.

■ **What is the maximum speed?**

The maximum speed is 6kmh/ 4mph

■ **How do I remove the rear wheels?**

By pressing the button in the centre of each wheel, which will then release it from the frame.

■ **How long does the battery take to charge?**

5 hours maximum - Do not charge for more than 24 hours.

■ **Can I charge the eFOLDi Lite with the battery left in?**

No the battery must be removed from your eFOLDi Lite for charging. It simply unclips from its position.

■ **How far will my eFOLDi Lite go on a charge?**

The range can be influenced by the varying conditions but on normal flat dry conditions up to 22km/14 miles.

Frequently asked questions



■ Are there keys with my eFOLDi Lite?

No.

■ What sort of braking system does my eFOLDi Lite have?

The eFOLDi Lite has a magnetic braking system linked to its throttle, as you release the throttle the brake is progressively engaged. The magnetic brake can be released should you need to free wheel the eFOLDi Lite.

■ Can I take my eFOLDi Lite on an aeroplane?

The eFOLDi Lite and its battery are fully airline compliant, but should be verified with each airline before traveling.

■ Do I need to register my eFOLDi Lite with the DVLA? (UK only)

No, as it is a class 2 mobility device (pavement scooter)

Technical specifications

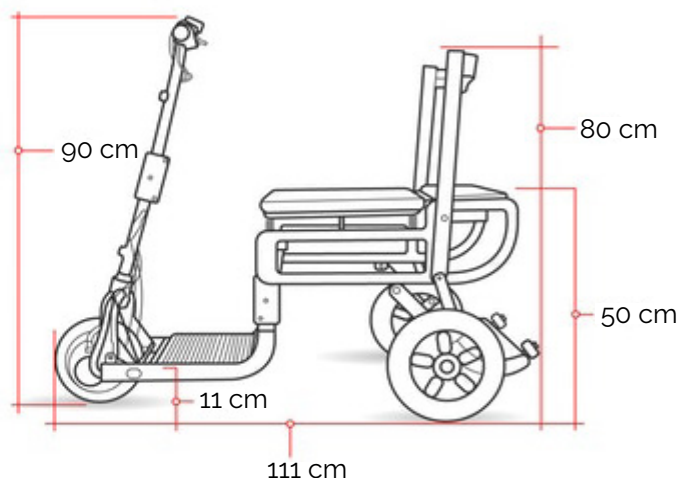
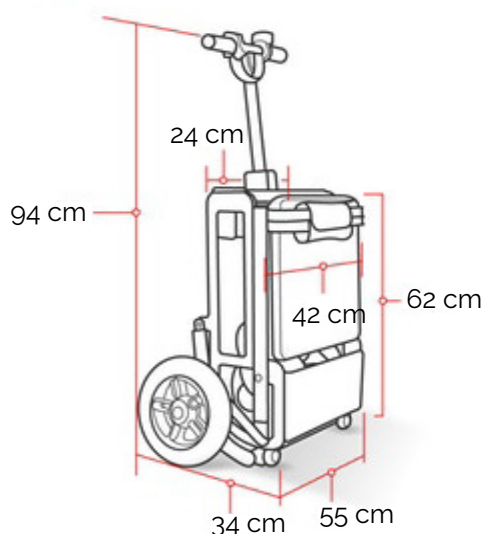

DIMENSIONS

Folded dimensions (L/W/H): 62x53x31cm (24x21x12.5')

Unfolded dimensions (L/W/H): 110x53x90cm (43x21x35.5')

Packaging dimensions (L/W/H): 57x41x70cm (22x16x27')

Seat height: 50cm/20'

Footrest height: 10cm/4'

Front wheel size: 20.3cm/8'

Rear wheel size: 25.4cm/10'

Ground clearance: 8cm/3.1'

WEIGHT

Weight with battery: 15kg/(33lbs)

Weight without battery: 13kg/(28lbs)

PERFORMANCE

Speed: 4mph/6kmh

Maximum range capacity: 14miles/22km

Maximum carry capacity: 120kg/265lbs/19st

Maximum gradient percentage: 1:6 (9.5 degrees)

COMPONENTS CAPABILITY

Motor: 250W 24V Hub Motor

Battery standard: 10ah Li-Ion

Brake: Electric magnetic

Main switch: Push button

Lights: No light

Number of wheels: 3

Turning radius: 100cm/39'

Quick release wheel: Yes

ENVIRONMENT

Place to use: Pavement and indoor



SunTech UK Ltd
25 Ormside Way, Redhill
Surrey, RH1 2LW, UK

EC

REP

MedPath GmbH
Mies-van-der-Rohe-Strasse 8
80807 Munich, Germany

www.efoldi.com

Services@efoldi.com